

1. PROVIDE ONE GFI 120VAC 15A OUTLET CLOSE TO THE BACK OF TOWER ONLY IF A MIN 24" ACCESS WAY IS AVAILABLE, OTHERWISE COORDINATE WITH LIFT INSTALLER
2. PROVIDE ALSO ONE WIRE AT THE SAME PLACE 120VAC, 15A
3. ENSURE AN ADEQUATE LIGHTING FOR THE VEHICLE AND THE LANDING BY ELECTRICIEN

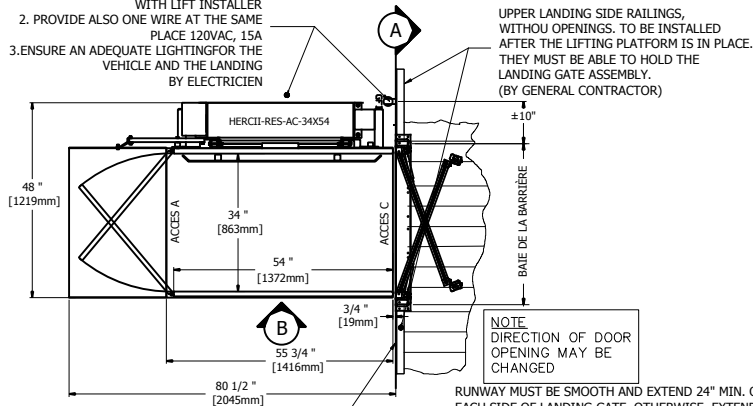

**1** **HERCII RES ST**  
**34x54 (WITH HELPER)**

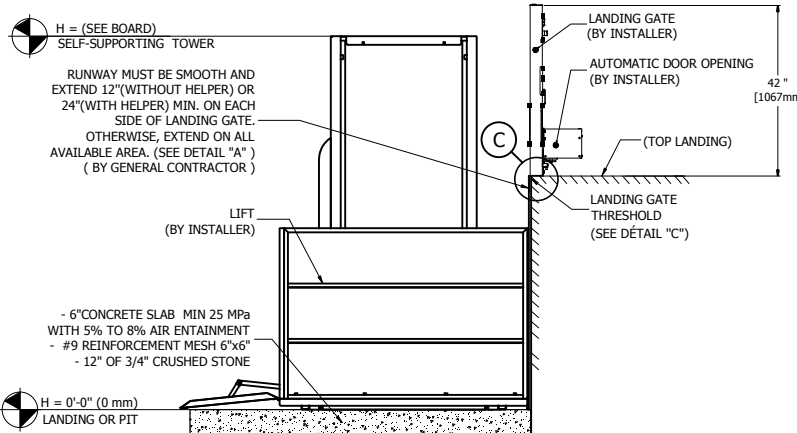

**3** **DETAIL B**  
**FLOOR ELEVATION**

- NOTE**
1. PROVIDE 100 lx MIN. LIGHTING TO THE WHOLE PLATFORM (BY ELECTRICIAN).
  2. ANY WALL LOCATED LESS THAN 12" (WITHOUT HELPER) OR 24" (WITH HELPER) AWAY FROM THE CAB MUST EXCEED THE UPPER LANDING HEIGHT BY AT LEAST 42". IT MUST BE SMOOTH (NO RECESSES OR PROTRUSIONS).

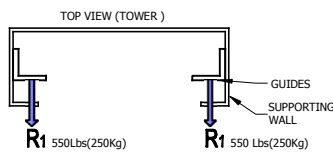

**5** **RAIL REACTIONS**

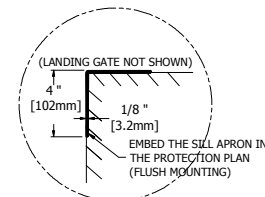

**4** **DETAIL C**

HERCULES II RES TECHNICAL DATA	
TYPE	Outdoor use, vertical lift, open shaft
CODE	CSA/B613
MAX CAPACITY	One person a wheelchair or One person a wheelchair and one helper
MAX LOAD	750 Lb (340 Kg)
RAIL LINEAR WEIGHT	5 Lb/ft
TRACTION MACHINE	Acme screw and nut
ALIMENTATION	DC, 24 VOLT
VELOCITY	9 pi/min (0.05m/s) *option max speed: 14pi/min (0.07m/s)
MAX TRAVEL	98po (2500 mm) max.
EMERGENCY BRAKES	Bronze safety nut
FINI DE LA CABINE	See document C-01
CABINE	Max floor dimensions 40x66po (1018mm x1679mm)
FINI DU PLANCHER	Anti-skid floor surface
CONTROL BUTTONS	Weatherproof control buttons
CONTOLER	BECVIS23 (CSA/LR45147)
DOOR INTERLOCK	HONEYWELL (RELIALIGN) or GAL (TYPE N)

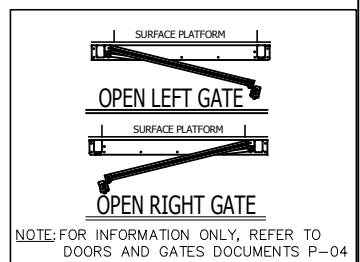

- NOTE**
- THIS ELECTRONIC DOCUMENT IS NOT SIGNED OR SEALED BY AN ENGINEER AND MAY NOT BE USED FOR CONSTRUCTION PURPOSES.
  - THIS ELECTRONIC DOCUMENT IS STRICTLY FOR INFORMATION PURPOSES (OR COORDINATION, AS APPLICABLE).
  - NO GUARANTEES ARE GIVEN ON THE INTEGRITY OF THE TRANSMITTED INFORMATION.
  - NO GUARANTEES ARE GIVEN ABOUT PAST OR FUTURE CHANGES TO THIS DOCUMENT

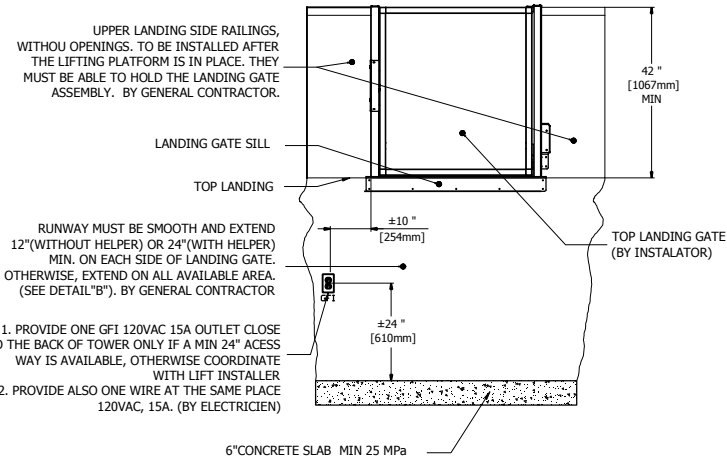

**2** **DETAIL A**  
**SIDE VIEW**

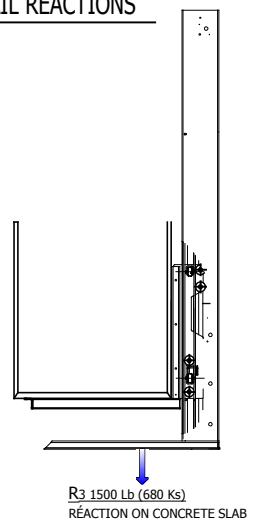

**5** **HERCII DC 750 Lb**  
**REACTIONS**

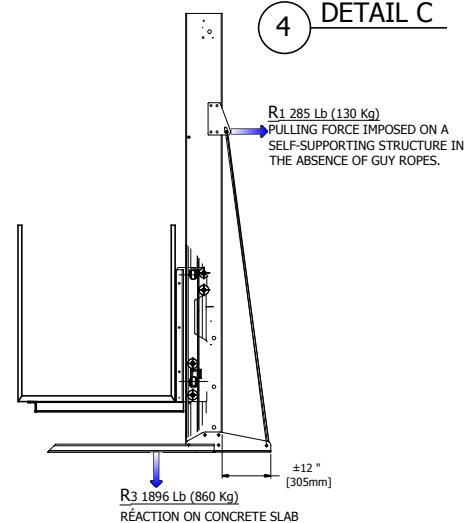

**6** **HERCII DC 1000 Lb**  
**REACTIONS**

**AmeriGlide**  
Accessibility Solutions

TITLE: **General Information**

No. DRAWING: Straight Thru	DATE: 28/01/2016	REVISION:
CODE: Hercules II DC Res	DRAFTER: M.Debusschere	No SHEET: 1/1